

ENG
EDITION_2

INDUSTRIAL CHAINS

HOIST CHAINS

for manual and
motor-driven hoists



HOIST CHAINS

for manual
and motor-driven hoists

FOR US THERE IS ONLY ONE OBJECTIVE: BEING BETTER

Advantages „Being Better“	2
Hoist Chains Performance/ Applications	3
DAT type, case hardened	4
NEW: D-Profil-Chain – DAT	5
T, tempered	6
NEW: D-Profile-Chain – T	7
VH, tempered	8
RPA/RSA, rust-free	9
Corrosion protection coatings	10
RUD Portal	10
Test reports – RUD hoist chains	11
Wheels Standard packing RUD hoist chains	12
RUD Limit gauge	13
Requirements on RUD hoist chains	14
Lubricants/ recommended lubricants	14

CHAIN HARDNESS

Uniform surface hardness and depth, particularly in the joints, excellent wear resistance, long service life.

GEOMETRY

Narrow dimensional tolerances, symmetrical link shape, fine control using take-up wheels.

CALIBRATION

All RUD Hoist Chains are 100% calibrated.

PRODUCTION

Made in Germany, at our Aalen-Unterkochen plant.

DEVELOPMENT

Collaboration with German technical institutes and hoist equipment manufacturers.

STRENGTH

Outstanding dynamic strength, maximum operating safety.

IDENTIFICATION

Chain identification is essential for clear safety information and traceability.

CHAIN DIMENSIONS

RUD makes the smallest and largest hoist chains in the world, with sizes 3 x 9 to 32 x 90 mm.

SERVICE

Reliable delivery, consultation and technical assistance worldwide from our RUD representatives.

WE SUPPLY ALL LEADING OEMs WORLDWIDE WITH OUR RUD HOIST CHAINS – „MADE IN GERMANY“

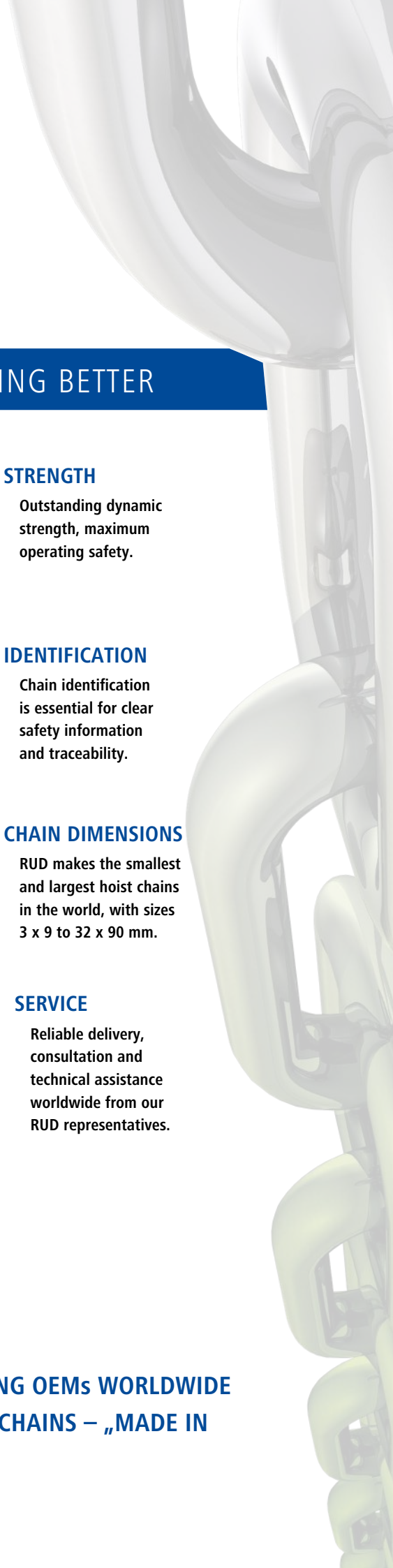

RUD HOIST CHAINS: PERFORMANCE - OVERVIEW

1. Raw materials



Available in a variety of qualities and sizes on coil or as rods.

2. Drawing the wire



The drawing machine draws the material to precisely the desired diameter.

3. Bending



Bending of the individual chain links: Each link is cleanly bent and laced into the next link.

4. Welding



Welding the links after bending.

5. Stamping



Stamping the welded chain with critical information: The RUD emblem, quality rating, manufacturing-number and batch number.

6. Heat treatment



Case hardened and quenched and tempered chains

7. Surface treatment



Black phosphated, galvanised, special coatings

8. Final calibration



The chain is precisely sized and loaded with manufacturing proof force.

9. Final acceptance



Quality assurance and acceptance.

10. Lubrication and packing



Warehousing and shipping.

APPLICATIONS FOR RUD HOIST CHAINS WIND POWER STATIONS · STAGE TECHNOLOGY · INDUSTRY · OFFSHORE



HARD SURFACE WITH TOUGH CORE – THE DAT TYPE

FOR HIGH WEAR RESISTANCE PER EN 818-7-DAT,
USING MOTOR-DRIVEN HOISTS

4

DAT/T quality class execution				Quality and designation			RTS	RTD	RTB
Mechanism group ISO 4301-1 (FEM 9.511)	Nominal stress [N/mm ²]	Limit stress [N/mm ²]		Stress at manufacturing proof force	σ_{FPmin}	N/mm ²	500		
			Stress at breaking force	σ_{Bmin}	N/mm ²	800			
M1 (1Dm)	200	250	Total ultimate elongation	A_{min}	%	10			
M2 (1Cm)	160	225	Surface hardness according to DIN EN 818-7	$d \leq 6,5 \varnothing$ $d \geq 7 \varnothing$	HV 5 HV10	500 - 650			
M3 (1Bm)	160	200				Case depth in the joint (after macro-etching)	...d $\pm 0,01 d$	mm	$\leq \varnothing 4 / 0,05$
M4 (1Am)	140	180	$\varnothing 4,1-7 / 0,04$						
M5 (2m)	125	160	Fatigue strength		N/mm ²	130 ± 80	130 ± 90	130 ± 100	
M6 (3m)	112	140							
M7 (4m)	100	125							
M8 (5m)	90	112							

Dimensions [mm]	Material No.	Load capacity F_{tr} [kg] according to mechanism group				Manu- facturing proof force FFPmin [kN]	Breaking force FBmin [kN]	RTS	RTD	RTB	Weight kg / m
		M3 (1Bm)	M4 (1Am)	M5 (2m)	M6 (3m)						
		Nominal stress: 160 N/mm ²	Nominal stress: 140 N/mm ²	Nominal stress: 125 N/mm ²	Nominal stress: 112 N/mm ²						
		Safety factor 5	Safety factor 5.7	Safety factor 6.4	Safety factor 7.1						
3¹⁾ x 9	7985902	230	200	180	160	7	11,3	x			0,19
4 x 12	7100183	410	350	320	280	12,6	20,1	x	x	x	0,35
5 x 15	7100184	640	560	500	440	19,6	31,4	x	x	x	0,54
6 x 18	7101362	920	800	720	640	28,3	45,2	x	x		0,78
6,3 x 19	7983648	1000	880	790	710	31,2	49,9	x			0,86
6,3 x 19,1	7102922	1000	880	790	710	31,2	49,9	x			0,86
7 x 21	7102168	1250	1090	980	870	38,5	61,6	x	x	x	1,1
7 x 22	7100185	1250	1090	980	870	38,5	61,6	x	x		1,1
7,1 x 20,2	7103637	1250	1090	980	870	39,6	63,3	x		x	1,1
7,1 x 21,2	7102924	1290	1130	1000	900	39,6	63,3	x			1,1
8 x 24	7101363	1640	1430	1280	1140	50,3	80,4	x			1,4
9 x 27	7100186	2070	1810	1620	1450	63,6	102	x	x	x	1,8
10 x 28	7102169	2560	2240	2000	1790	78,5	126	x			2,2
10 x 30,2	7102926	2560	2240	2000	1790	78,5	126	x			2,2
11 x 31	7102955	3100	2700	2420	2160	95	152	x			2,7
11,2 x 34	7102927	3200	2800	2500	2240	98,5	157,6	x			2,7
11,2 x 34,4	7102930	3200	2800	2500	2240	98,5	157,6	x			2,7
11,3 x 31	7992923	3270	2860	2550	2280	100,3	160,5	x	x	x	2,85
13 x 36	59733	4330	3780	3380	3030	132,7	212,3	x		x	3,8
16 x 45	55004	6550	5730	5120	4590	201	322	x		x	5,7
23,5¹⁾ x 66	7993516	14100	12370	11000	9900	434	694	x			12,2

¹⁾ Dimensions outside of EN 818-7. Other dimensions on request.

The nominal stresses and the limit stresses may not exceed the stresses specified in the respective mechanism groups. Operating temperature - 20° C to + 200° C.

RUD D-PROFILE-CHAIN – DAT TYPE

FOR HIGH WEAR RESISTANCE PER EN 818-7-DAT,
USING MOTOR-DRIVEN HOISTS

DAT/T quality class execution			<p>Case hardened</p>	Quality and designation			RTS	RTD	RTB
Mechanism group ISO 4301-1 (FEM 9.511)	Nominal stress [N/mm ²]	Limit stress [N/mm ²]		Stress at manufacturing proof force	σ_{FPmin}	N/mm ²	500		
M1 (1Dm)	200	250		Stress at breaking force	σ_{Bmin}	N/mm ²	800		
M2 (1Cm)	160	225		Total ultimate elongation	A_{min}	%	10		
M3 (1Bm)	160	200		Surface hardness according to DIN EN 818-7	$d \leq 6,5 \varnothing$ $d \geq 7 \varnothing$	HV 5 HV10	500 - 650		
M4 (1Am)	140	180		Case depth in the joint (after macro-etching)	$\dots d$ $\pm 0,01 d$	mm	$\leq \varnothing 4 / 0,05$ $\varnothing 4,1-7 / 0,04$ $\varnothing 8-16 / 0,03$ $\geq \varnothing 16,1 / 0,02$	$< \varnothing 8 / 0,05$ $\varnothing 8-11,5 / 0,04$ $\geq \varnothing 12 / 0,03$	
M5 (2m)	125	160		Fatigue strength		N/mm ²	130 ± 80	130 ± 90	130 ± 100
M6 (3m)	112	140							
M7 (4m)	100	125							
M8 (5m)	90	112							

Dimensions [mm]	Quality	Material No.	Load capacity F_{tr} [kg] according to mechanism group				Manu- facturing proof force FFPmin [kN]	Breaking force FBmin [kN]	Manufacturing length	Weight kg / m
			M3 (1Bm)	M4 (1Am)	M5 (2m)	M6 (3m)				
			Nominal stress: 160 N/mm ²	Nominal stress: 140 N/mm ²	Nominal stress: 125 N/mm ²	Nominal stress: 112 N/mm ²				
			Safety factor 5	Safety factor 5.7	Safety factor 6.4	Safety factor 7.1				
3,7 x 12	RTD	7907103	380	340	320	270	12,6	20,1	200m	0,34
3,75 x 10,75	RTS	7909389	380	340	320	270	12,6	20,1	200m	0,34
5 x 14,3	RTD	7907401	680	630	540	480	21,3	34,0	200m	0,61
5,25 x 15	RTS	7908823	800	670	630	530	24,7	39,5	200m	0,59
7 x 21	RTD	7903473	1400	1220	1090	970	43	68,8	100m	1,20
7,45 x 23	RTS	7909391	1540	1350	1200	1080	50	80	150m	1,35
9,6 x 30	RTD	7907402	2560	2240	2000	1790	78,5	126	100m	2,15

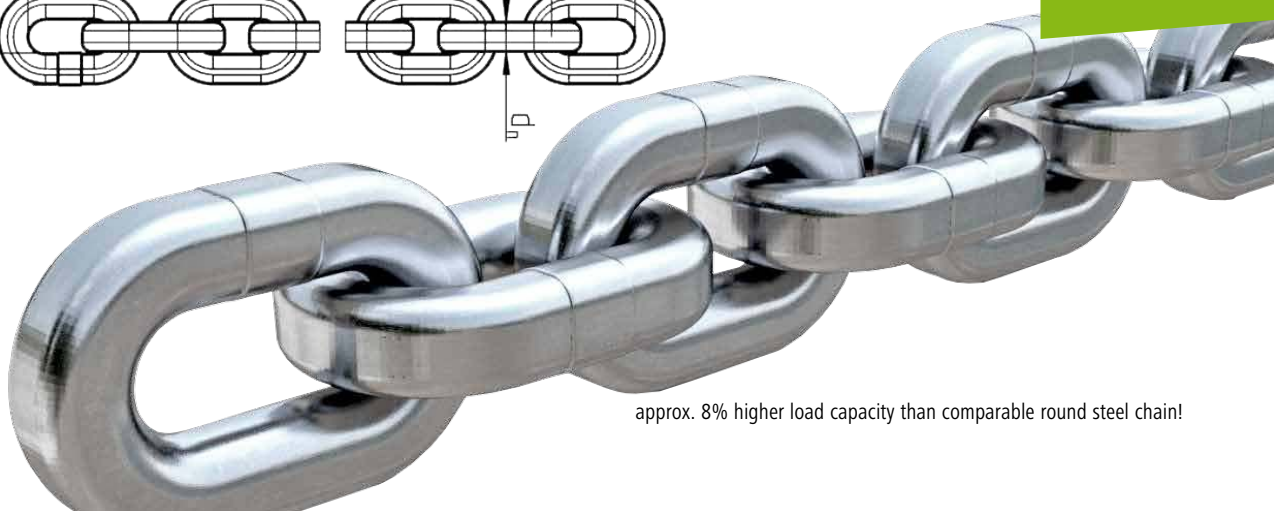
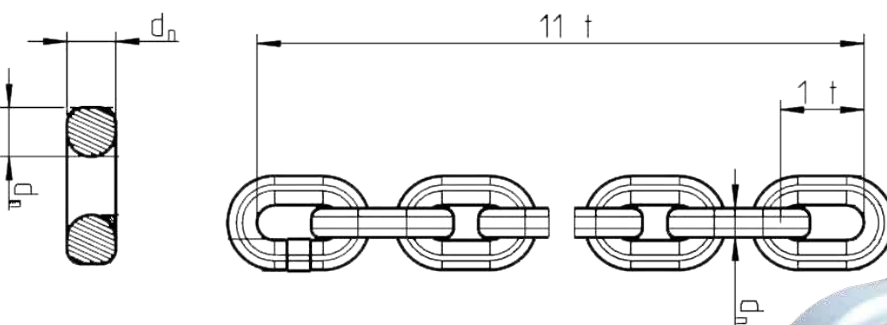

NEW

approx. 8% higher load capacity than comparable round steel chain!

RUD HOISTING CHAINS - T TYPE

FOR LOW/MODERATE WEAR APPLICATIONS PER EN 818-7-T,
SPECIAL DESIGNED FOR MANUAL HOISTS

6

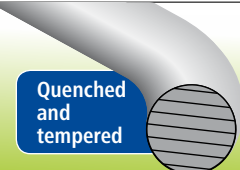
 Quenched and tempered	Quality and designation			RT
	Stress at manufacturing proof force	σ_{FPmin}	N/mm ²	500
	Stress at breaking force	σ_{Bmin}	N/mm ²	800
	Total ultimate elongation	A_{min}	%	10
Surface hardness in the joint			HV10	360



Dimensions [mm]	Material No.	Load capacity F_{tr} [kg] according to mechanism group					Manufacturing proof force F_{FPmin} [kN]	Breaking force F_{Bmin} [kN]	Weight kg / m
		Hand (1Dm)	M3 (1Bm)	M4 (1Am)	M5 (2m)	M6 (3m)			
		Nominal stress: 200 N/mm ² Safety factor 4	Nominal stress: 160 N/mm ² Safety factor 5	Nominal stress: 140 N/mm ² Safety factor 5,7	Nominal stress: 125 N/mm ² Safety factor 6,4	Nominal stress: 112 N/mm ² Safety factor 7,1			
3¹⁾ x 9	7989206	280	230	140	180	160	7	11,3	0,19
4 x 12	53804	510	410	350	320	280	12,6	20,1	0,35
5 x 15	53008	800	640	560	500	440	19,6	31,4	0,54
5,6 x 17	57165	1000	800	700	630	560	24,6	39,4	0,68
6 x 18	56680	1150	920	800	720	640	28,3	45,2	0,78
6 x 18,5	60144	1150	920	800	720	640	28,3	45,2	0,8
6,3 x 19	7985347	1270	1010	880	790	710	31,2	49,9	0,86
6,3 x 19,1	53012	1270	1010	880	790	710	31,2	49,9	0,86
7 x 22	56709	1560	1250	1090	980	870	38,5	61,6	1,1
7,1 x 21	53016	1560	1250	1090	980	870	39,6	63,3	1,1
7,1 x 21,2	62168	1560	1250	1090	980	870	40	67	1,1
8 x 24	62162	2050	1640	1430	1280	1140	50,3	80,4	1,4
9 x 27	55376	2590	2070	1810	1620	1470	63,6	102	1,8
10 x 28	7101451	3200	2560	2240	2000	1790	78,5	126	2,2
10 x 30	57862	3200	2560	2240	2000	1790	78,5	126	2,2
11 x 31	60931	3870	3100	2710	2420	2170	95	152	2,7
11,2 x 34	53028	4010	3200	2810	2500	2250	98,5	157,6	2,7
13 x 36	53030	5400	4320	3780	3380	3030	132,7	212,3	3,8
16 x 45	53017	8150	6550	5730	5110	4590	201	322	5,7
22 x 66	7989369	15500	12500	10840	9680	8680	400	630	10,7
23,5¹⁾ x 66	7992988	17680	14140	12380	11050	9900	434	694	12,2
32¹⁾ x 90	7993904	32790	26200	22950	20480	18360	780	1286	21,3

¹⁾ Dimensions outside of above mentioned standards. Other dimensions on request.

The nominal stresses and the limit stresses may not exceed the stresses specified in the respective mechanism groups. Operating temperature - 40° C to + 200° C.

RUD D-PROFILE-CHAIN – T TYPE

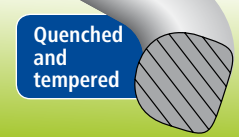
FOR LOW/MODERATE WEAR APPLICATIONS PER EN 818-7-T,
SPECIAL DESIGNED FOR MANUAL HOISTS

 <p>Quenched and tempered</p> 	Quality and designation			RT
	Stress at manufacturing proof force	σ_{FPmin}	N/mm ²	500
	Stress at breaking force	σ_{Bmin}	N/mm ²	800
	Total ultimate elongation	A_{min}	%	10
	Surface hardness in the joint		HV10	360

7

Dimensions [mm]	Quality	Material No.	Chain load	Manufacturing proof force F_{FPmin} [kN]	Breaking force F_{Bmin} [kN]	Manufacturing length	Weight kg / m
			Hand (1Dm)				
			Nominal stress: 200 N/mm ²				
			Safety factor 4				
4 x 12	RT	–	550	13,7	21,9	–	0,37
5 x 15	RT	–	870	21,3	34,1	–	0,59
6 x 18	RT	–	1250	30,7	49,2	–	0,86
7 x 21	RT	–	1700	41,8	66,9	–	1,14
8 x 24	RT	–	2230	54,7	87,5	–	1,40
9 x 27	RT	–	2820	69,1	110,6	–	1,90
10 x 30	RT	–	3480	85,4	136,6	–	2,42

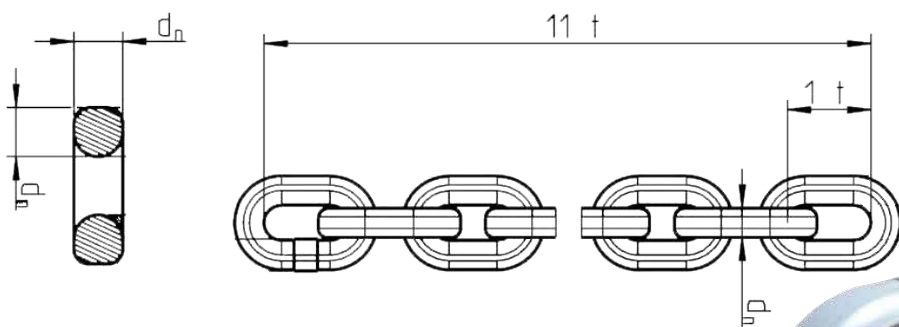

NEW

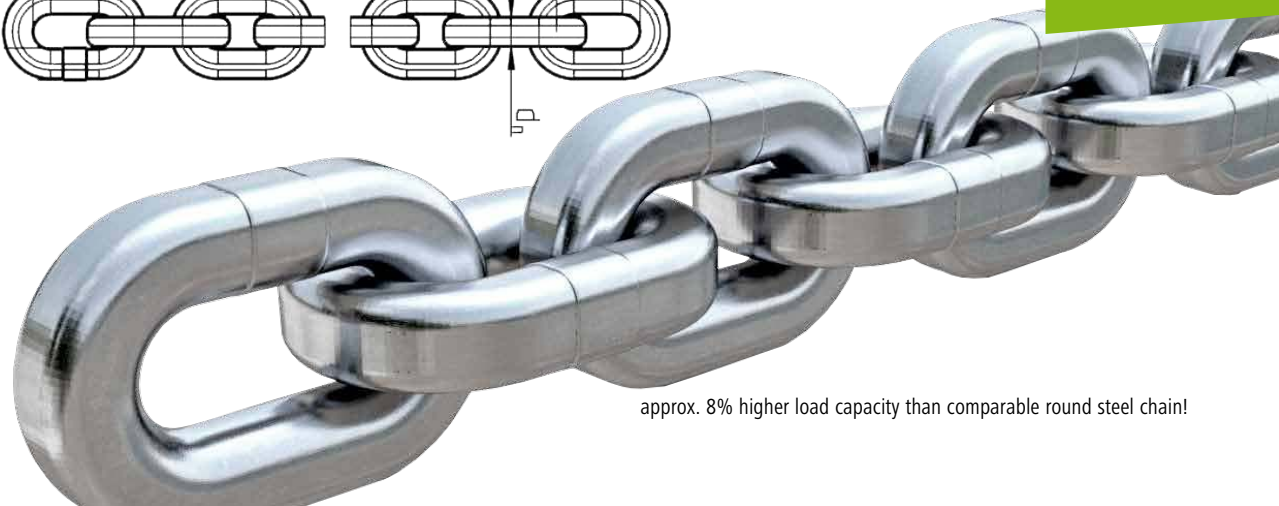

approx. 8% higher load capacity than comparable round steel chain!

HEAVY DUTY APPLICATIONS – VH TYPE

FOR USE IN MANUAL HOISTS ISO 16872

8

	Quality and designation			VH
	Stress at manufacturing proof force	σ_{FPmin}	N/mm ²	625
	Stress at breaking force	σ_{Bmin}	N/mm ²	1000
	Total ultimate elongation	A_{min}	%	17
	Surface hardness in the joint		HV10	min. 430

Dimensions [mm]	Material No.		Load capacity F_{tr} [kg] according to mechanism group Load traction force: 250 N/mm ² Safety factor 4	Manufacturing proof force F_{FPmin} [kN]	Breaking force F_{Bmin} [kN]	Weight kg /m
	Surface matte blue	Surface Corrud-DT				
	4 x 12	7905884				
5 x 15	7900678	7901399	1000	24.5	39.3	0.54
5.6 x 17	7901430	7901431	1250	30.8	49.3	0.68
6 x 18	7901262	7901400	1440	35.3	56.5	0.78
6.3 x 19.1	7900646	7901401	1600	39	62.3	0.86
7.1 x 21	7901086	7901402	2000	49.5	79.2	1.1
7.1 x 21.2	7900647	7901407	2000	49.5	79.2	1.1
8 x 24	7900679	7901403	2500	62.8	101	1.4
9 x 27	7900680	7901404	3150	79.5	127	1.8
10 x 30	7900925	7901405	4000	98.2	157	2.2
10 x 30.2	7901061	7901406	4000	98.2	157	2.2
13 x 36	7905267	-	6750	165.9	265.5	3.8

Chains in accordance with ISO 16872 may only be installed/used in manually operated hoists.
Operating temperature - 40° C to + 150° C

SIMPLY SAFE - RUD HAND CHAINS

Galvanised hand chain, not certificated		
Dimensions	Designation	P/n [100 m length]
5 x 18,5	Galvanised hand chain	8502628
5 x 23,5	Galvanised hand chain	8502627
5 x 23,8	Galvanised hand chain	8502970
5 x 24	Galvanised hand chain	8502626
5 x 25	Galvanised hand chain	8502563
5 x 25,2	Galvanised hand chain	8502629
5 x 26	Galvanised hand chain	8502632
6 x 18,7	Galvanised hand chain	8501629
5 x 18,5	open chain link	7101773
5 x 24	open chain link	7101770
5 x 25	open chain link	59381

1.4404 stainless steel hand chain, not certificated		
Dimensions	Designation	P/n
5 x 18,5	Stainless steel hand chain	63656
5 x 24	Stainless steel hand chain	7103866
5 x 25	Stainless steel hand chain	53943
5 x 25,2	Stainless steel hand chain	62473
5 x 18,5	open chain link	8500193
5 x 25	open chain link	8500194



RUST AND ACID RESISTANT QUALITY

SIMILAR TO DIN 5684 PARTS 1 AND 2,
FOR MOTOR-DRIVEN AND MANUAL HOISTS



Quality classes RPA and RSA				
Mechanism group ISO 4301-1 (FEM 9.511)	Nominal stress: [N/mm ²]		Limit stress [N/mm ²]	
	RPA	RSA	RPA	RSA
M1 (1Dm)	125	160	187.5	240
M2 (1Cm)	100	125	138	175
M3 (1Bm)	100	125	125	160
M4 (1Am)	90	112	112	140
M5 (2m)	80	100	100	125
M6 (3m)	70	90	90	112
M7 (4m)	60	80	80	100
M8 (5m)	55	70	70	90

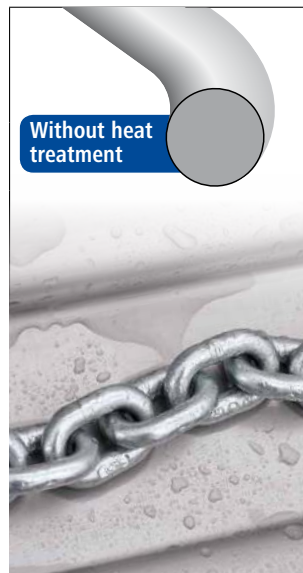

Quality and designation			Quality class P RPA	Quality class S RSA
Material			AISI 316	
Stress at manufacturing proof force	σ_{FPmin}	N/mm ²	315	400
Stress at breaking force	σ_{Bmin}	N/mm ²	500	630
Total ultimate elongation	A_{min}	%	15	
Surface hardness in the joint	$d \leq 6.5 \varnothing$ $d \geq 7 \varnothing$	HV 5 HV10	approx. 250	

Dimensions [mm]	Material No.	Quality class	Load capacity F_{tr} [kg] according to mechanism group					Manu- facturing proof force F_{FPmin} [kN]	Brea- king force F_{Bmin} [kN]	Weight kg / m
			Manual (1Dm)	M3 (1Bm)	M4 (1Am)	M5 (2m)	M6 (3m)			
			Nominal stress: $\leq \varnothing 7 = 160 \text{ N/mm}^2$ $\geq \varnothing 8 = 125 \text{ N/mm}^2$	Nominal stress: $\leq \varnothing 7 = 125 \text{ N/mm}^2$ $\geq \varnothing 8 = 100 \text{ N/mm}^2$	Nominal stress: $\leq \varnothing 7 = 110 \text{ N/mm}^2$ $\geq \varnothing 8 = 90 \text{ N/mm}^2$	Nominal stress: $\leq \varnothing 7 = 100 \text{ N/mm}^2$ $\geq \varnothing 8 = 80 \text{ N/mm}^2$	Nominal stress: $\leq \varnothing 7 = 90 \text{ N/mm}^2$ $\geq \varnothing 8 = 70 \text{ N/mm}^2$			
			Safety factor 4	Safety factor 5	Safety factor 5.7	Safety factor 6.4	Safety factor 7.1			
4 x 12	54079	S	400	320	280	250	230	10	16	0.35
5 x 15	54100	S	630	500	440	400	360	16	25	0.54
6 x 18	54333	S	900	720	630	570	510	22.4	36	0.78
6.3 x 19.1	53998	S	1010	790	700	635	570	25	40	0.86
7 x 21	54130	S	1250	1000	860	780	700	32	50	1.1
8 x 24	58778	P	1250	1000	920	820	710	32	50	1.4
9 x 27	58779	P	1600	1250	1160	1000	900	40	63	1.8
10 x 28	58780	P	2000	1600	1440	1250	1120	50	80	2.2
11.3 x 31	7984841	P	2500	2000	1800	1600	1400	63	100	2.85
13 x 36	58784	P	3350	2650	2430	2100	1890	85	132	3.8
16 x 45	7988746	P	5000	4000	3680	3270	2860	125	200	5.7

Other dimensions
on request.







The nominal stresses and the limit stresses
may not exceed the stresses specified
in the respective mechanism groups.

Attention: Because of the austenitic materials with low hardness,
reduction of the nominal stress and good lubrication of the chain will
produce a satisfactory service life.
For continuous operation, a nominal stress of $\sigma_{tr} = 80 \text{ N/mm}^2$
should not be exceeded for motor-driven hoists.

RUST OUT – SERVICE IN CORROSION PROTECTION COATINGS FOR RUD HOIST CHAINS

LIMIT GAUGES · PACKING

10

Surfaces	Short description of surface coating	New condition
Natural dark blue oil polished	Thick oxide layer with corrosion protection oil	
Phosphated oil polished (POP)	Zinc phosphate with corrosion protection oil (5 µm)	
Electrolytic galvanised	Electrolytic metal deposition (6-10 µm)	
Corrud-DT coating	Inorganic zinc-plated coating with a combination of zinc and aluminium plates	
Corrud-DS 240 coating	Coating similar to Corrud-DT, but with a supplementary organic topcoat.	
Corrud-DS 480 coating	Coating similar to Corrud-DS 240, but with more layers.	

RUD Portal

easy registration:

www2.rud.com or
e-mail: fhh@rud.com

 and more information about RUD hoist chain
www2.rud.com

RUD PORTAL – RUD HOIST CHAINS

- Operating instructions
- Lubricant recommendations
- Product presentations
- Discard criteria
- INDUSTRIAL CHAINS Brochures



TEST REPORTS – RUD HOIST CHAINS

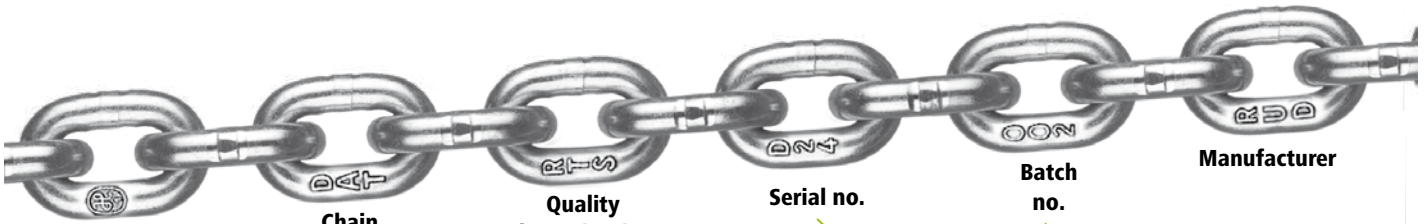

Kommanditgesellschaft
Sitz Aalen-Unterkochen
Amtsgericht Ulm
HRA 500160

Komplementärin
RUD-Kettenfabrik
Gabr. Rieger GmbH
Sitz Aalen-Unterkochen
Amtsgericht Ulm
HRB 600065

Geschäftsführer:
Dr. Hansjörg Rieger
Jörg S. Rieger, Ph.D.
Johannes W. Rieger
Benjamin T. Rieger

RUD Ketten Rieger & Dietz GmbH u. Co. KG 6-73428 Aalen, Germany Certified acc. to ISO 9001 and ISO 14001

S A M P L E !! =====	customer order no.: XXXXXX	serial no.: XXXXXX
	from: XXXXXX our ref.:HR/JSR/TEQ/ telephone: 07361/504- Aalen, 01.03.2015 RUD order no.: XXX cert.-No.: XXX quant. desp.: XXXX weight: XX	
Inspection Certificate 3.1 acc. to DIN EN 10204		
description: chain 4,00 x 12,20		RUD ref.:
quality grade: T		customer ref.:
type: D4T		
quality: RTS		
material: special chain steel		
condition of surface: galvanized		
working load limit / stress at working load limit:		
XXXX	XXXX	
XXXXXXXXXX	XXXXXXXXXX	
XXX	XXX	

We confirm the fulfillment of the required values according to RUD production

Guaranteed properties :

Dimensions:

CHAIN WHEEL DESIGN – THE SPECIAL RUD SERVICE

Constructive design of pocket wheels and chain guides, matched to the round link chain and hoist. Prototype wheel fabrication.

The result:

Maximum operating safety, long chain service life, quiet running chain, optimal mating of chain with wheel.

Please cite the following when ordering RUD pocket chain wheels:

- Chain size and number of pockets
- Hub length E + C
- Boring dia. B with fit (if not specified, we use fit H7 and boring chamfer 1.5 x 45°)
- Nut key DIN 6885 Bl. 1 P9 or JS9 or keyway with keyway direction
- Any threaded boring for setting screws with indication of position

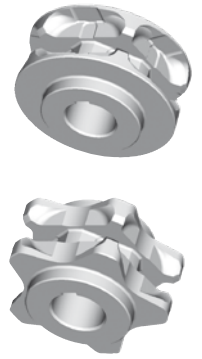

12

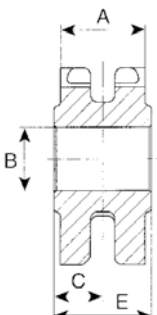
Chain d x t (mm)	Number of pockets	Pitch circle Ø	Crown width A	Max. boring B	Chain wheel design
5 x 15	5	48	25	20	
7 x 21	6	81	35	40	
9 x 27	6	104	45	50	
13 x 36	6	139	65	70	
16 x 45	6	174	80	90	
23.5 x 66	5	214	118	100	
Further wheel types available on request. The design and selection of shaft/hub coupling must be handled by the plant manufacturer in relation to the forces in play. Recommendation: $E \approx 1.7 \times B$					

STANDARD PACKING RUD HOIST CHAINS

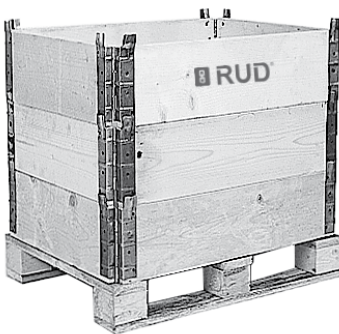

Standard packing RUD hoist chains.

including VCI film

Dimensions:

- 1 Stacking frame: 80 x 60 x 35 cm
- 2 Stacking frames: 80 x 60 x 55 cm
- 3 Stacking frames: 80 x 60 x 75 cm



New disposable packaging RUD box.

- Disposable packaging RUD 1: 80 x 60 x 55 cm
- Disposable packaging RUD 2: 80 x 60 x 75 cm

RUD LIMIT GAUGE FOR HOIST CHAINS

Manufacture	Motor driven Hoist	Manual driven Hoist	Article number
CM/Yale		×	7993866
CM/Yale	×		7996272
DEMAG (DK/DC+PK)	×		7101452
GIS	×		51622
HADEF		×	7995835
HADEF (AK+GEDI)	×		7900303
KITO		×	7994684
LIFTKET	×		7992010
J.D. NEUHAUS	×		62540
R.STAHL/STAHL CRANESYSTEMS	×		7994103
TIGER (T+VH)		×	7907394
VERLINDE/KONE/SWF	×		7993092
ABUS	×		7909386

...SIMPLE SETUP FOR FAST RESULTS...



- Our RUD limit gauge consists of a sturdy aluminium strip with guide holes for the measuring pins as well as locking holes for the locking studs attached to the measuring pin.
- The size of the chain to be tested – $d_n \times t$ – is engraved below the guide holes.

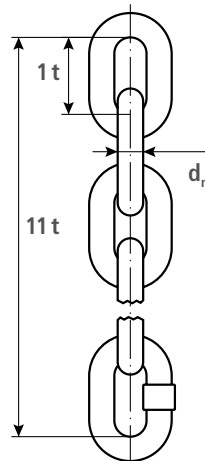

The two galvanised measuring pins provided with locking studs are located, together with the limit gauge, in a highquality softshell pocket.

d_n = Nominal diameter
 t = inner pitch attachment
11 t = Length over 11 links

More information about the RUD limit gauge in the separat brochure.

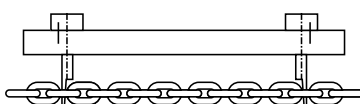

Gauge to be introduced:
chain is alright

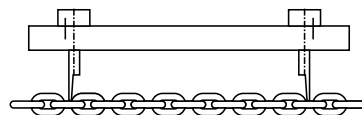

Gauge cannot be introduced:
chain has to be replaced wear > 2 %
respectively 3 %

ALWAYS IN MOVEMENT – REQUIREMENTS ON RUD HOIST CHAINS LOADS · HARDNESS · WEAR

Dynamic chain loading

Requirements per DIN EN 818-7

RUD meets the challenge of dynamic chain loading with the most modern fabrication and testing methods.

Example of dynamic chain loading in the hoist during the lifting cycle

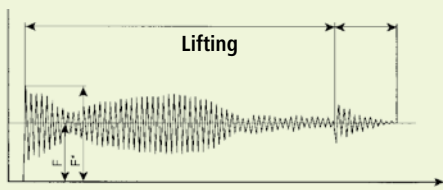

Dynamic chain testing in the pulsator

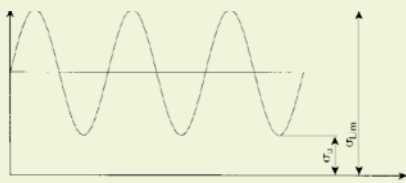

Traction relationship $R = \frac{\sigma_u}{\sigma_o} = 0,2$
 Limit vibration $n = 2 \times 10^6$
 Permitted limit traction $\sigma_o = \sigma_{Lim}$

Wear testing

Parameter:

Load traction $\sigma_{tr} = 100 \text{ N/mm}^2$
 Pocket number $Z = 5$
 Speed $v = 8 \text{ m/min}$.
 Dry, ungreased chain
 1 chain

A well lubricated chain and properly designed chain drive make for several times higher load alternation. As a rule of thumb: up to 15 times greater. The RTB quality can yield load cycles of up to 300.000.

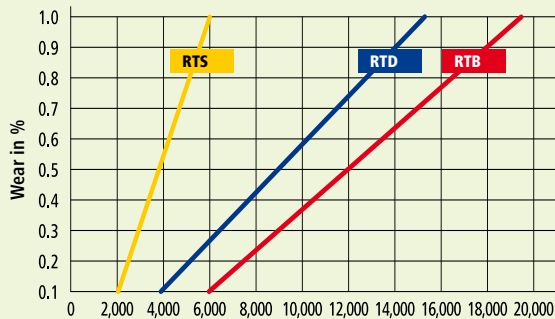

The quality classes relate to material, chain design and production process. Values given in case of test stand testing. Drive wheel, chain guide and scraper all designed and fabricated to the state of the art.

Tip: For RT chains, the load change number < 1000. Conditions such as abrasive dust reduce the load change number for all chains.

Hardness

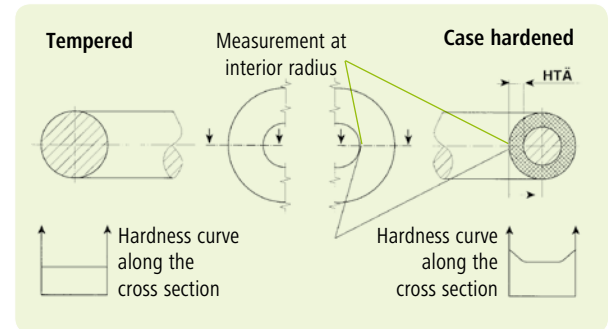

Example hardness curves

RTS quality = conventional heat treatment, low case hardening depth

RTD quality = modified fabrication process

RTB quality = chain with especially high wear resistance. In addition, this quality is optimised for vibration resistance.

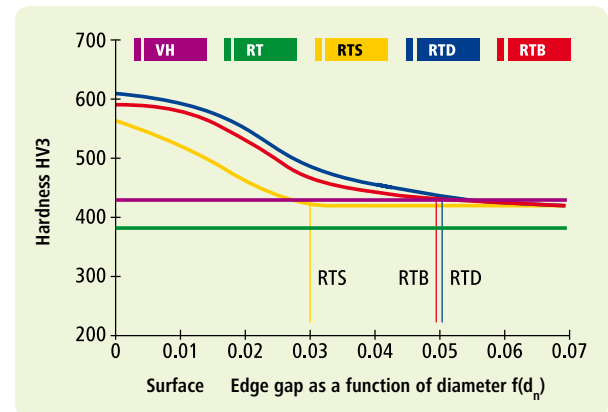

Traction - stretch diagram

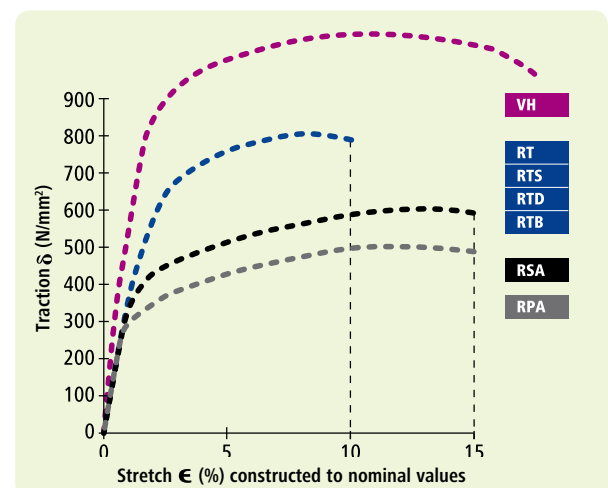

MATERIALS CONSTANTLY IN MOVEMENT

THE FUCHS LUBRITECH LUBRICANTS LISTED BELOW HAVE PROVED THEIR VALUE FOR LUBRICATING HOIST CHAINS IN PRACTICE.

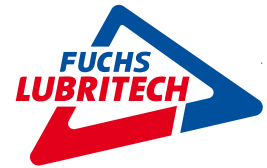

STABYLAN 2001 Partly synthetic lubricant with creep and outstanding lubricating qualities, as well as excellent corrosion proofing. Application range -15°C to $+150^{\circ}\text{C}$. Available as spray, open canisters or drums. Tried and tested **standard RUD lubricant for general applications.**

CEPLATTYN 300 Graphite paste with high-pressure and adhesion agents, creates an almost dry dust-repellent solid lubricant film, application from -30°C to $+250^{\circ}\text{C}$. Available in open containers or as spray. **For use per mining hygiene regulations (GesBergV) above and below ground.**

STABYLAN 5006 Fully synthetic high temperature chain lubricant (chain honey) **for extreme temperatures up to 240°C .** Salt water resistant, mineral oil resistant, penetrates and displaces water, outstanding adhesion. Available as a spray, in canisters and drums.

CASSIDA CHAIN OIL 1500 Fully synthetic high performance chain lubricant with very good adhesion and extreme resistance to being washed off. Temperature range -10°C to $+140^{\circ}\text{C}$. Available in canisters, drums, or as a spray. Listed per NSF H1 and suited **to use in the vicinity of food.** Especially suited to meat processing applications, approved for KOSHER and HALAL processing.

DECORDYN 350 High adhesion corrosion proofing film with good lubrication qualities, for temperatures -40°C to $+70^{\circ}\text{C}$. used in **wind power installations, offshore and for general protection in aggressive environments.**

YOUR CONSULTANCY PARTNER

FUCHS LUBRITECH GMBH Tel.: +49 (0) 6301 3206-0
 Werner-Heisenberg-Straße 1 Fax: +49 (0) 6301 3206-940
 67661 Kaiserslautern Email: info@fuchs-lubritech.de
<http://www.fuchs-lubritech.com>

Chain lubrication

When running over the drive and reversing wheels, the chain links are unwound under load.

In order to minimise the friction between links, the hoist chain must be lubricated regularly in relation to the operating conditions.

- The indicated load cycles are achieved with a dry, ungreased chain with load traction force of 100 N/mm^2 , pocket wheel $Z = 5$ and speed $V = 8 \text{ m/min}$.

Regular chain lubrication

- Regular lubrication enables a 15-20 times increase in the load cycle rating over a dry, ungreased chain.
- When lubricating the chain, take care that the lubricant penetrates into the links subject to wear.



LOAD CYCLE RATING WITH UNLUBRICATED CHAIN

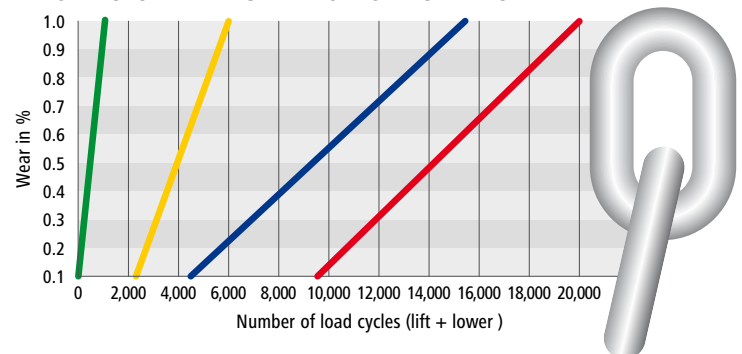

NUMBER OF LOAD CYCLES WITH LUBRICATED CHAIN

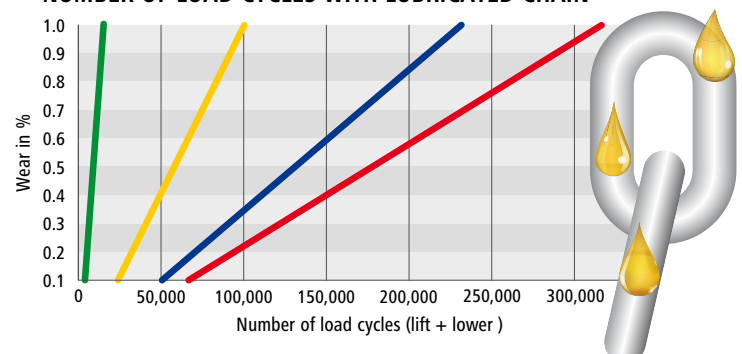



CONVEYING AND DRIVING



Whether it's complete bucket conveyors, chain conveyors or chain drives, our vast experience in all bulk goods including cement, fertilisers, stone and clays among many others make RUD the choice for your application.



For power generation with coal and biomass, as well in recycling, RUD is a leading technology supplier offering components and complete solutions using round link chains and FORKY. Whether it's material feeding, ash removal or cleaning scrapers, RUD CRATOS has the solution you require.



RUD Powerblock and Dominator chain shackles are the global benchmark for the industry and are used in heavy duty mining applications worldwide due to their outstanding reliability.



RUD is the first choice for the following international hoisting equipment manufacturers. We also offer a wide range of round link chains for a variety of industrial applications.



The RUD TECDOS Team develops and fabricates drive solutions for turning, lifting, moving telescoping and pushing. Along with our component program, we now offer complete solutions with the TECDOS Omega and Pi drives.