

Vario-Starpoint VRS-F-3/4"-10UNC with star key

Artikel-Nr: 7104483



- Lifting points pivots 360°. Easy adjustment in load direction.
- Not exchangeable RUD-Bolt (this reduces the usage of improper standard bolts).
- Clear marking of the minimum WLL for all loading directions. Higher WLL possible when location and installation is optimised (compare WLL chart / product information).
- Clear marking at the bolt head: RUD, thread size, batch-no.
- Variable bolt lengths available for tapped or through holes.
- Available as: - Standard Metric Thread (DIN EN 13) - Metric Fine Thread (DIN EN 13) - Coarse Pitch Thread UNC (ANSI B1.1) - Fine Thread 8UN (ANSI B1.1) - Inch Pipe Thread (DIN 228)
- Significant product characteristics of the VRS are subject to property right claims.
- Component according to the test criterias of BG/DGUV "GS-OA-15-04".
- Complying with the US-Standard (ASME B30.26). Quick and easy installation with just one bolt connection.
- Installation and disassembly without any further tools than the exchangeable Easy-Fit star profile key for singular lifts.
- For permanent installation and recurrent lifts we can offer a special socket wrench to apply the requested torque (fits to a common Inch torque wrench).

Other important RUD specific information and specialities to our RUD lifting points can be found in the specific user instruction.

Vario-Starpoint VRS-F-3/4"-10UNC with star key

Artikel-Nr: 7104483

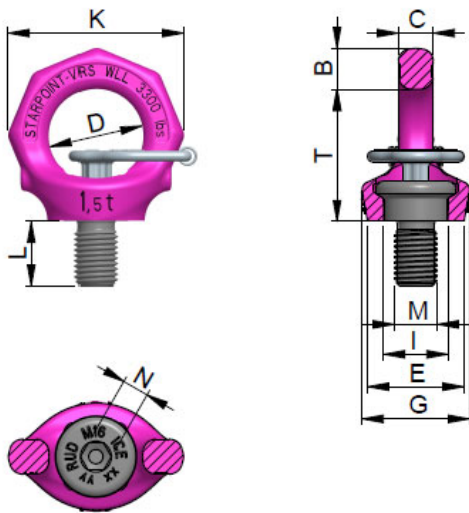

weight	0.54 kg	1.19 lbs
Nominal WLL	2300 kg	5070 lbs
T	58 mm	2-9/32"
B	17 mm	43/64"
C	16 mm	5/8"
D	40 mm	1-9/16"
E	41 mm	1-5/8"
G	50 mm	1-31/32"
I	29,3 mm	1-5/32"
K	76 mm	3"
L	29 mm	1-5/32"
M	3/4"-10UNC mm	3/4"-10UNC
N	1/2" mm	1/2"