

Eye bolt RS-7/8"-9BSW

Artikel-Nr: 51816



- **Considerably higher WLL** (in comparison to DIN 580/582) at vertical load.
- **Large thread and WLL range** (M6-M48, 0.1 t – 8 t).
- **Clear marking of the minimum WLL for all loading directions**
- Quick and easy installation with just one bolt connection.
- In accordance with the test principles of DGUV GS-OA-15-04, eyebolts with rigid eyes serve as mounting aids, e.g. on motors and gear units. There is a trade association clearance certificate available for using the high-strength RUD RS eyebolts.

Other important RUD specific information and specialities to our RUD lifting points can be found in the specific user instruction.

Eye bolt RS-7/8"-9BSW

Artikel-Nr: 51816

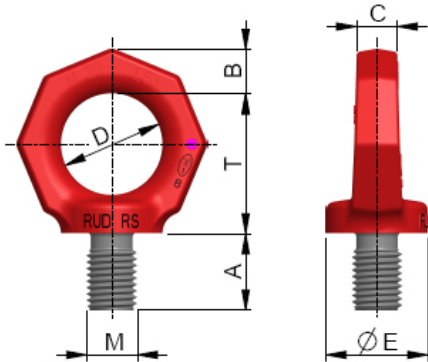

weight	0.80 kg	1.76 lbs
Nominal WLL	1500 kg	3300 lbs
T	70 mm	2-3/4"
A	34 mm	1-11/32"
B	21 mm	13/16"
C	20 mm	3/4"
D	50 mm	1-31/32"
E	50 mm	1-31/32"
M	7/8" mm	7/8"