

PSA-STARPOINT PSA-VRS M16 with max. Length L=120mm

Artikel-Nr: 8600401



- **Lifting points pivots 360°**
- **They are corresponding to a "anchor point" according to European edict 2016/425** and the DIN 795:2012-10 resp. DIN CEN / TS 16415:2013-4 and they are marked with CE and the number of load bearing persons (=1 or 2 persons).
- **These products are certified by a notified institution of DGUV** (Deutsche Gesetzliche Unfallversicherung): DGUV-test certificate No.: PS17060031, PS17060032 and PS17060033 with the evidence of the in OSHA 1926.502: 2001/01 paragraph (d)(15) and DIN EN 50308:2005 chapter 4.5 for lifting points required Forces.
- **Non removable special bolt**(this reduces the risk of improper standard bolts).
- Available as: - Standard Metric Thread (DIN EN 13)
- Quick and easy installation with just one bolt connection.
- Hand tightening with appropriate wrench is sufficient for a singular lift.

Other important RUD specific information and specialities to our RUD lifting points can be found in the specific user instruction.

PSA-STARPOINT PSA-VRS M16 with max. Length L=120mm

Artikel-Nr: 8600401

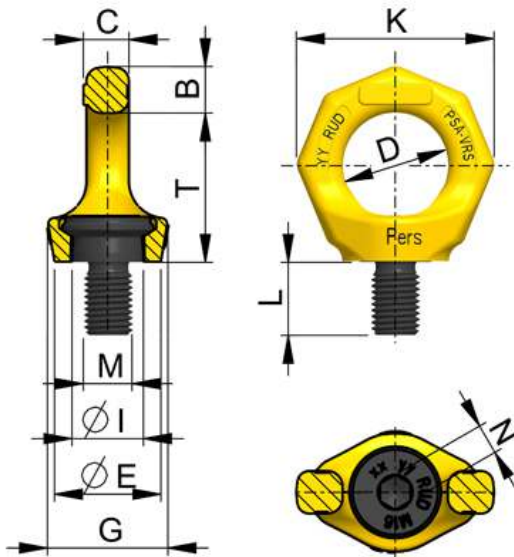

	weight	0.48 kg	1.06 lbs
T	50 mm	1-31/32"	
B	16 mm	5/8"	
C	15 mm	19/32"	
D	35 mm	1-3/8"	
E	35 mm	1-3/8"	
G	40 mm	1-9/16"	
I	24 mm	15/16"	
K	65 mm	2-9/16"	
L	120 mm	4-3/4"	
M	M16 mm	M16	
N	10 mm	3/8"	